

FÔRMAS PARA CAIXAS, GRELHAS, RALOS E MOLDURAS.

PEC MAQ[®]
PEC FORMAS
A sua Fábrica de Fôrmas

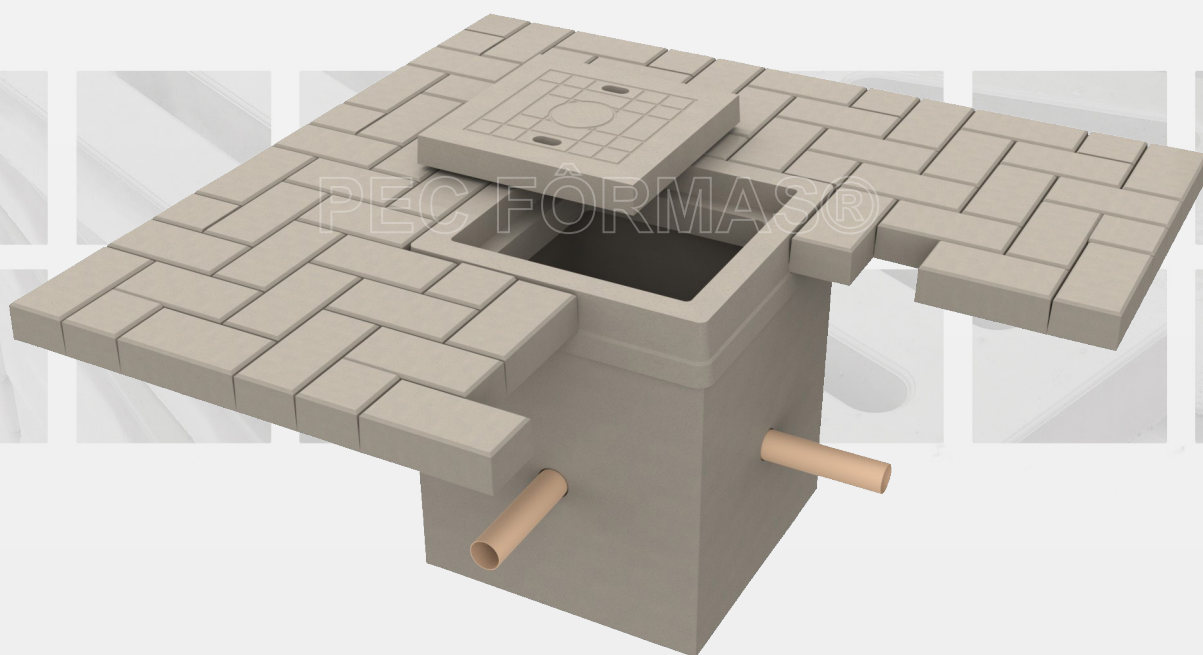

FÔRMAS PLÁSTICAS PARA GRELHAS, RALOS E MOLDURAS.



Código	Medidas (cm)
-	-
BS032	50 x 50 x 6
-	-



Código	Medidas (cm)
-	-
BS452	50 x 50 x 6
-	-



Código	Medidas (cm)
BS008-A	60 x 60 x 6
BS009-A	50 x 50 x 6
BS011-A	30 x 30 x 4

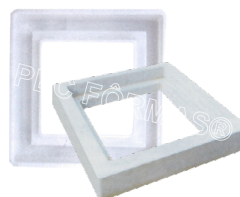

Código	Medidas (cm)
BS008	71,5 x 71,5 x 11,5
BS009	60 x 60 x 11
BS011	41 x 41 x 9,5



Exemplo de Montagem

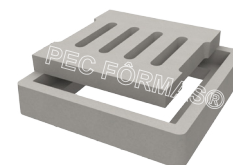

Exemplo de Montagem

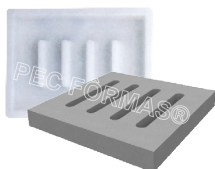

Código	Medidas (cm)
BS010-B	39,5 x 39,5 x 5

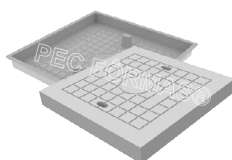

Código	Medidas (cm)
BS010-A	39,5 x 39,5 x 5,5

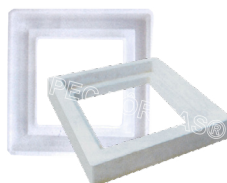

Código	Medidas (cm)
BS010	52 x 52 x 10



Exemplo de Montagem



Imagem Ilustrativa

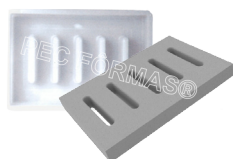

Código	Medidas (cm)
BS021-A	60 x 40 x 6
-	-
-	-
BS024-A	45 x 30 x 6
-	-
BS145-A	50 x 30 x 6

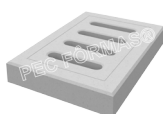

Código	Medidas (cm)
-	-
-	-
-	-
-	-
BS025-A	35 x 25 x 5
-	-

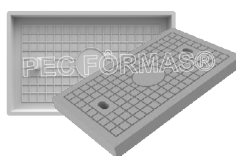

Código	Medidas (cm)
BS013-A	60 x 40 x 6
BS014-A	54 x 39 x 6,5
BS015-A	50 x 35 x 6
BS016-A	45 x 30 x 6
BS017-A	35 x 25 x 5
-	-



Código	Medidas (cm)
BS013	71,5 x 52 x 11
BS014	65 x 50 x 11
BS015	60 x 45 x 11
BS016	55 x 40 x 10
BS017	45,5 x 35 x 9
BS145	60 x 40 x 10



Exemplo de Montagem



Exemplo de Montagem



Código	Medidas (cm)
BS012-A	75 x 45 x 6

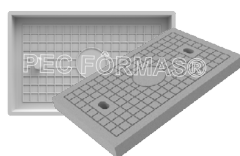

Código	Medidas (cm)
BS012-B	75 x 45 x 6

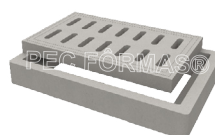

Exemplo de Colocação
Fôrma para Moldura

Código	Medidas (cm)
BS012	86 x 56 x 11



Código	Medidas (cm)
BS450	60 x 29,5 x 6

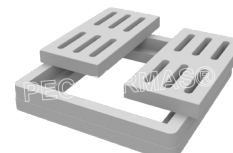

Exemplo de Colocação

Fôrma para Moldura

Código	Medidas (cm)
BS008	71,5 x 71,5 x 11,5



Código	Medidas (cm)
BS151-A	60 x 40 x 10



Exemplo de Colocação

Fôrma para Moldura

Código	Medidas (cm)
BS151	73 x 53 x 15



Imagem Ilustrativa

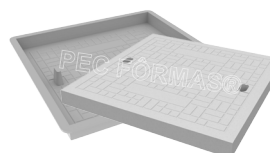

Código	Medidas (cm)
BS153-A	70 x 70 x 6

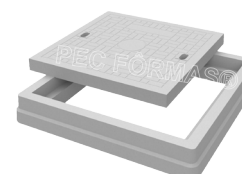

Exemplo de Colocação

Fôrma para Moldura

Código	Medidas (cm)
BS153	85 x 85 x 12

*Fôrma Sob Encomenda

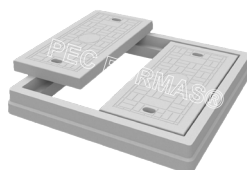
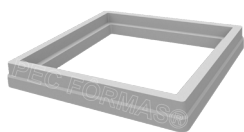
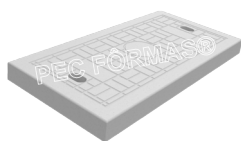

Exemplo de Montagem

Imagem Ilustrativa

Imagem Ilustrativa

Código	Medidas (cm)
BS154-A	80 x 40 x 6
BS155-A	100 x 50 x 6
BS156-A	88 x 48,5 x 6

Código	Medidas (cm)
BS154	95 x 95 x 12,5
BS155	114 x 114 x 12
BS156	100 x 100 x 11

*Fôrmas Sob Encomenda



Código	Diã. (cm)	Prof. (cm)
BS007-A	30	-
BS006-A	40	6
BS005-A	49,5	6
BS004-A	60	-
BS002-A	79,5	6,5

Código	Diã. (cm)	Prof. (cm)
BS007	39,5	9
BS006	52,5	10
BS005	63,5	11
BS004	72	11
BS002	98,5	13,5

Exemplo de Montagem com o Tubo FTP088

Código	Diã. (cm)	Prof. (cm)
BS003-A	69,5	6

Código	Diã. (cm)	Prof. (cm)
BS003	82,5	13

FÔRMAS METÁLICAS PARA CAIXAS

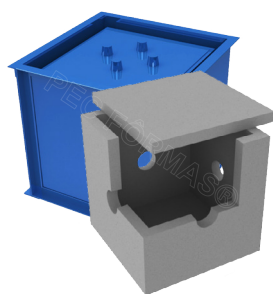

Fôrma para Caixa Elétrica

Código	Comp. (cm)	Larg. (cm)	Alt. (cm)
CXE013	30	30	30
CXE014	40	40	40
CXE015	50	50	50
CXE016	60	60	60
CXE017	70	70	70
CXE018	80	80	80

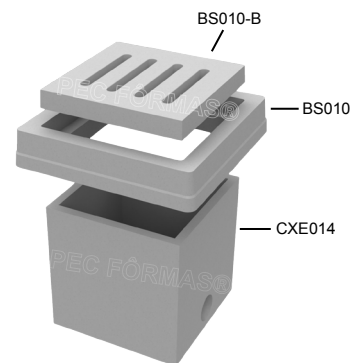
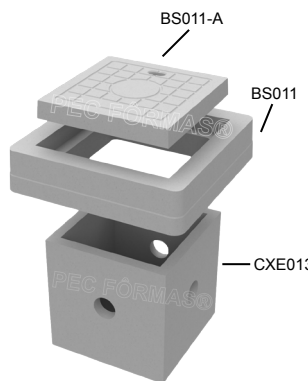

Exemplos de Acabamentos (Fôrmas Vendidas Separadamente)



CXE014 / BS010 / BS010-A



CXE015 / BS009 / BS009-A



CXE015 / BS009 / BS032



CXE016 / BS008 / BS008-A

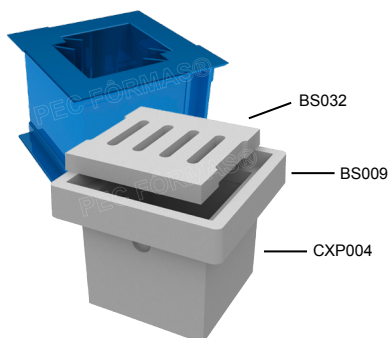

Fôrma para Caixa de Gordura

Código	Comp. (cm)	Larg. (cm)	Alt. (cm)	Parede (cm)
CXG001	50	30	26	2,5
CXG002	50,9	29	45	3
CXG003	65	65	67,5	2,5
CXG009	50	50	40	2,5
CXG014	40	40	35	2,5
CXG020	59	44	44,5	2,5



Fôrma para Caixa de Passagem

Código	Comp. (cm)	Larg. (cm)	Alt. (cm)	Parede (cm)
CXP003	65	65	82,5	2,5
CXP004	45	45	37,5	2,5
CXP005	45	35	25	2,5
CXP006	65	65	47,5	3
CXP007	65	65	62,5	3
CXP008	50	40	40	2,5
CXP010	50	40	30	4
CXP011	65	49	47,5	3
CXP012	65	50	65,5	2,5
CXP014	63	48	36	2,5



Fôrma para Caixa de Ar Condicionado

Código	Comp. (cm)	Larg. (cm)	Alt. (cm)	Parede (cm)
CXAC-3	40	56	56	2,5
CXAC-3G	40	56	56	2,5
CXAC-2	49	73	77	4
CXAC-2G	49	73	77	4
CXAC-E	Conforme medidas fornecidas pelo cliente			

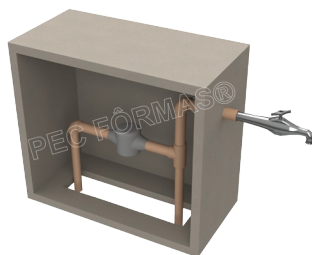

Fôrma para Abrigo de Cavalete D'água ou Gás

Código	Comp. (cm)	Larg. (cm)	Alt. (cm)
CXA001	56	28	50
CXAG001	45	55	25



**SOLICITE NOSSOS CATÁLOGOS COMPLETOS, OU
ACESSE NOSSO SITE E CONHEÇA TODA NOSSA
LINHA DE FÔRMAS, MOLDES E MÁQUINAS PARA
ARTEFATOS DE CIMENTO.**

WWW.PECFORMAS.COM.BR



PECMAQ[®]
PECFORMAS
A sua Fábrica de Fôrmas

Rua Lucília Peres, 98
Jardim Esther Yolanda
CEP 05374-150 São Paulo - SP
Brasil

TEL: 11 3719-2934
vendas@pecformas.com.br
www.pecformas.com.br